

# Opstilling af tavler

## Frihøjder og friafstande

### Placering i tværprofil (normal)

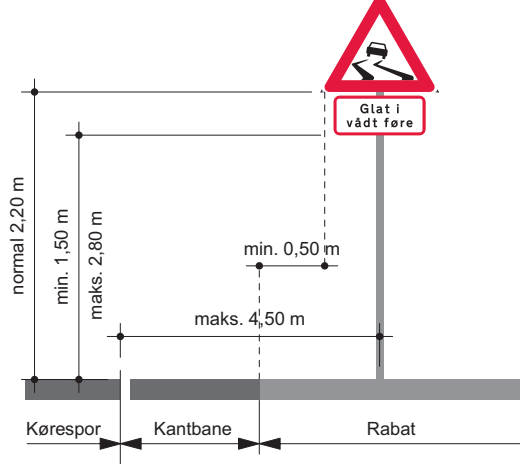

### Placering i tværprofil (cykelsti og fortov)

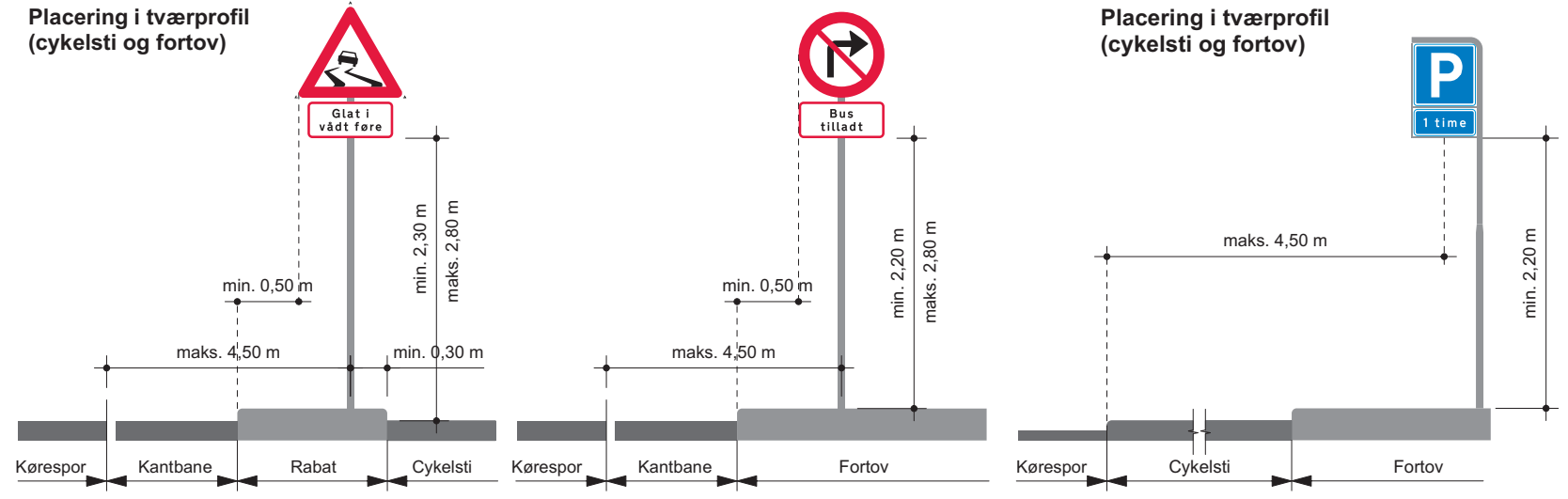

### Placering i tværprofil (midterhelle)

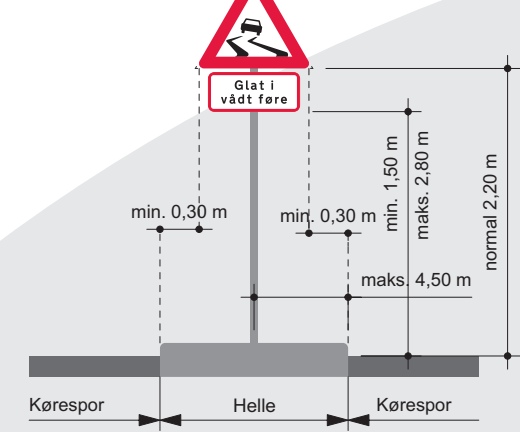

### Lav placering

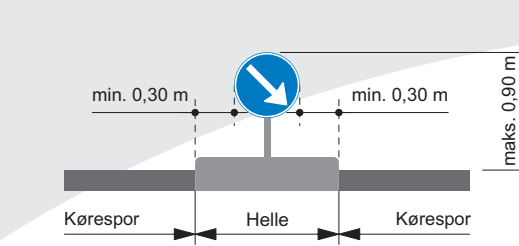

### Høj placering

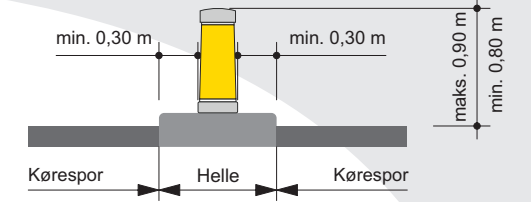
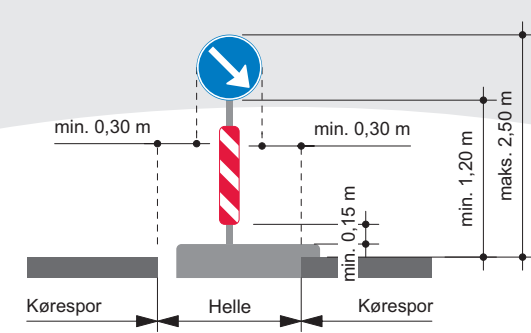

### Diagramorienteringstavle

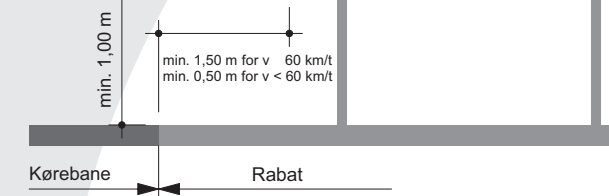
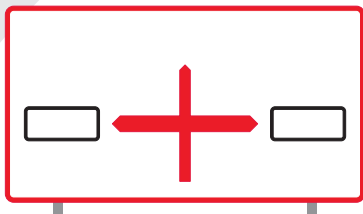

### Diagramorienteringstavle

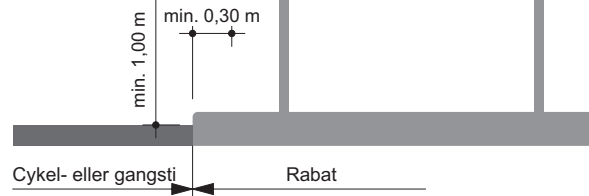
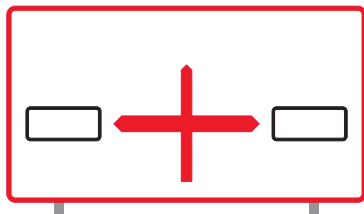

### Tabelorienteringstavle

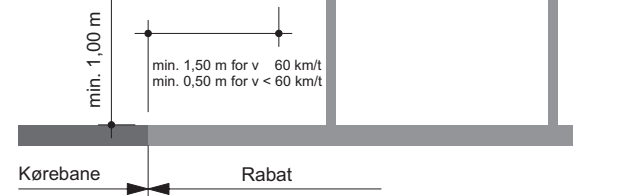

### Tabelorienteringstavle

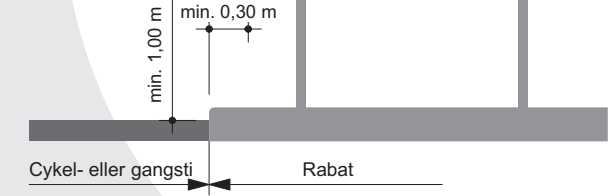

### Afstandstavle

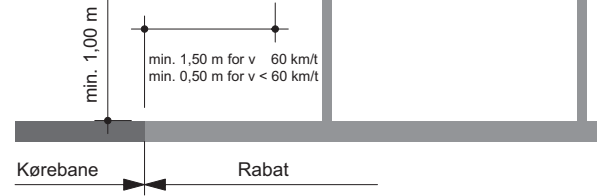

### Afstandstavle

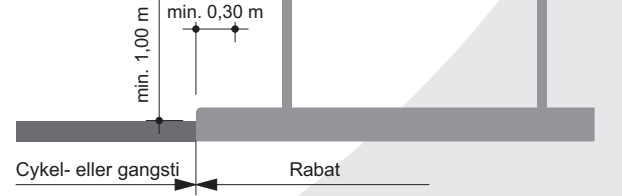
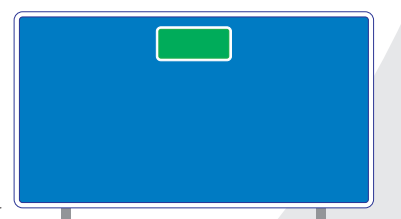

### Pilvejviser (235 mm)

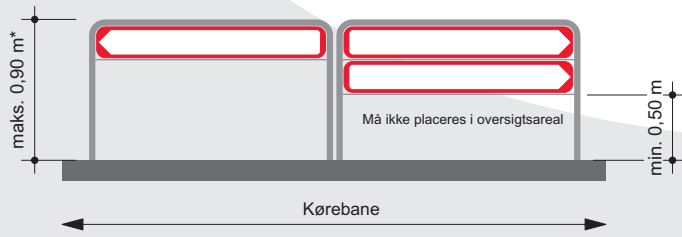

\* Gælder i kryds, hvor oversigt generes af pilvejviseren.

### Tværprofil

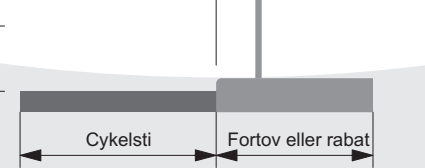

\*\* Pilvejviseren placeres i bagkant af fortov, hvis muligt.

### Pilvejviser (330 mm)

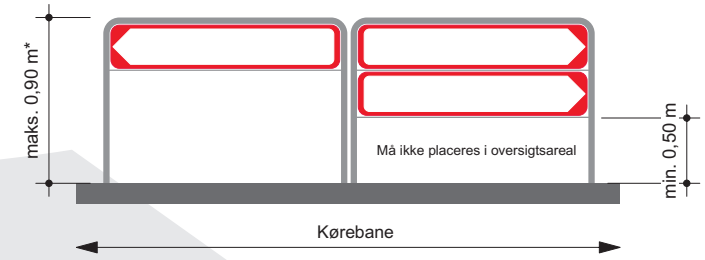

\* Gælder i kryds, hvor oversigt generes af pilvejviseren.

### Tværprofil

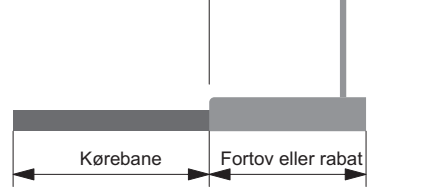

\*\* Pilvejviseren placeres i bagkant af fortov, hvis muligt.

### Frakørselsvejviser

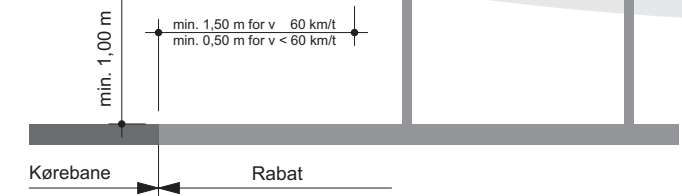

### Tabelvejviser

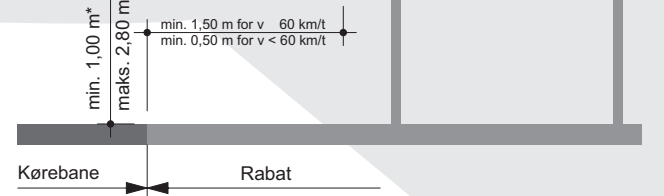

\* i oversigtsareal min. 2,50 m

### Tabelvejviser

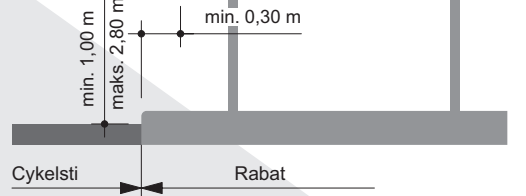

### Lave placeringer

#### Stivejvisning

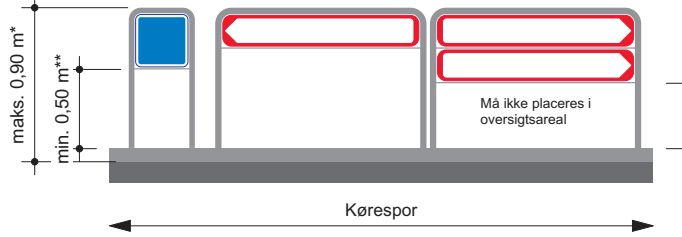

#### Almindelig vejvisning

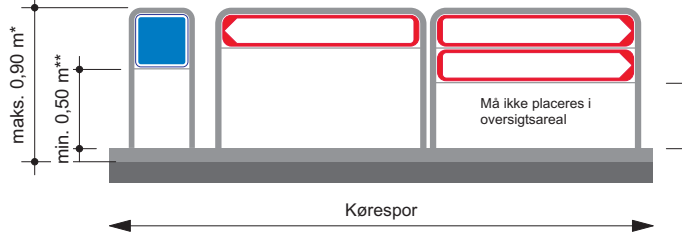

\* Gælder i kryds, hvor oversigt generes af sti- og pilvejviseren.  
\*\* Normalt minimum på 0,50 m pga. græs og sne.

### Tværprofil

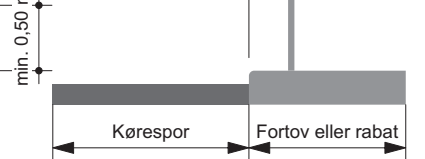

\*\*\* Sti- og pilvejviseren placeres i bagkant af fortov, hvis muligt.

### Stivejvisning

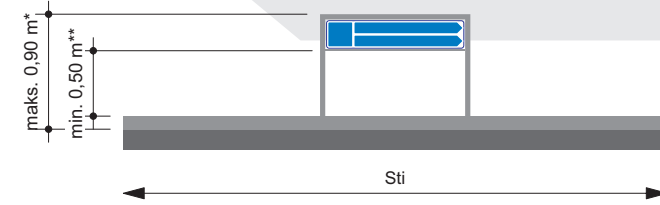

\* Gælder i kryds, hvor oversigt generes af sti- og pilvejviseren.  
\*\* Normalt minimum på 0,50 m pga. græs og sne.

### Tværprofil

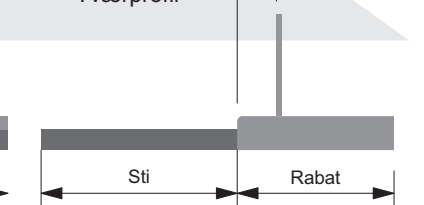

## Reflekstyper Sådan kender du forskel

	<b>Engineer Grade</b> "Almindelig refleks" Type 3 Kendetegn: Metallic look		<b>High Intensity Prismatic Grade</b> "HIP" Type 4 Kendetegn: Hønsenetmønster med striber
	<b>High Intensity</b> "Kortlyrefleks" Type 4 Kendetegn: Bicellemønster		<b>Diamond Grade</b> Type 5 Kendetegn: Hønsenetmønster

Reflekstyperne findes i mange farver

### Høj placering

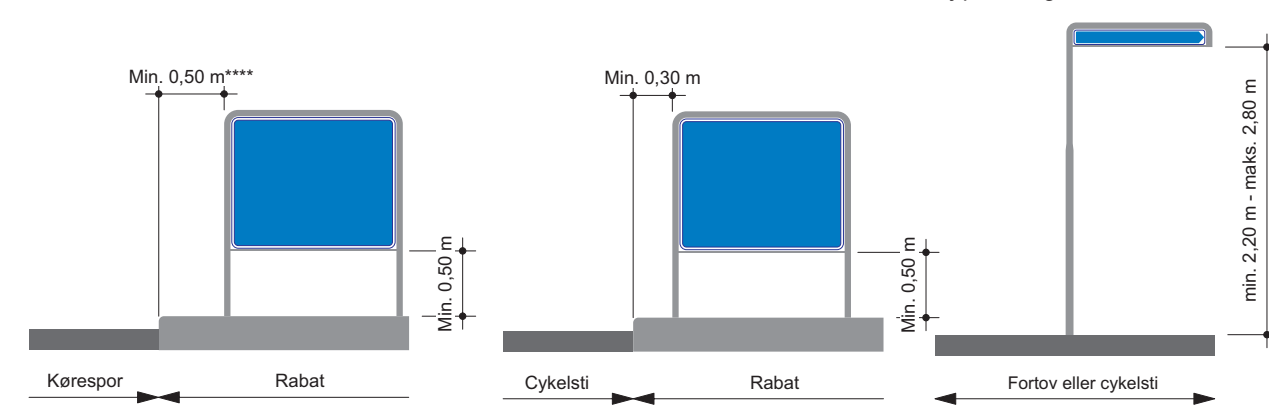

\*\*\*\* I by mindre, hvis nødvendigt

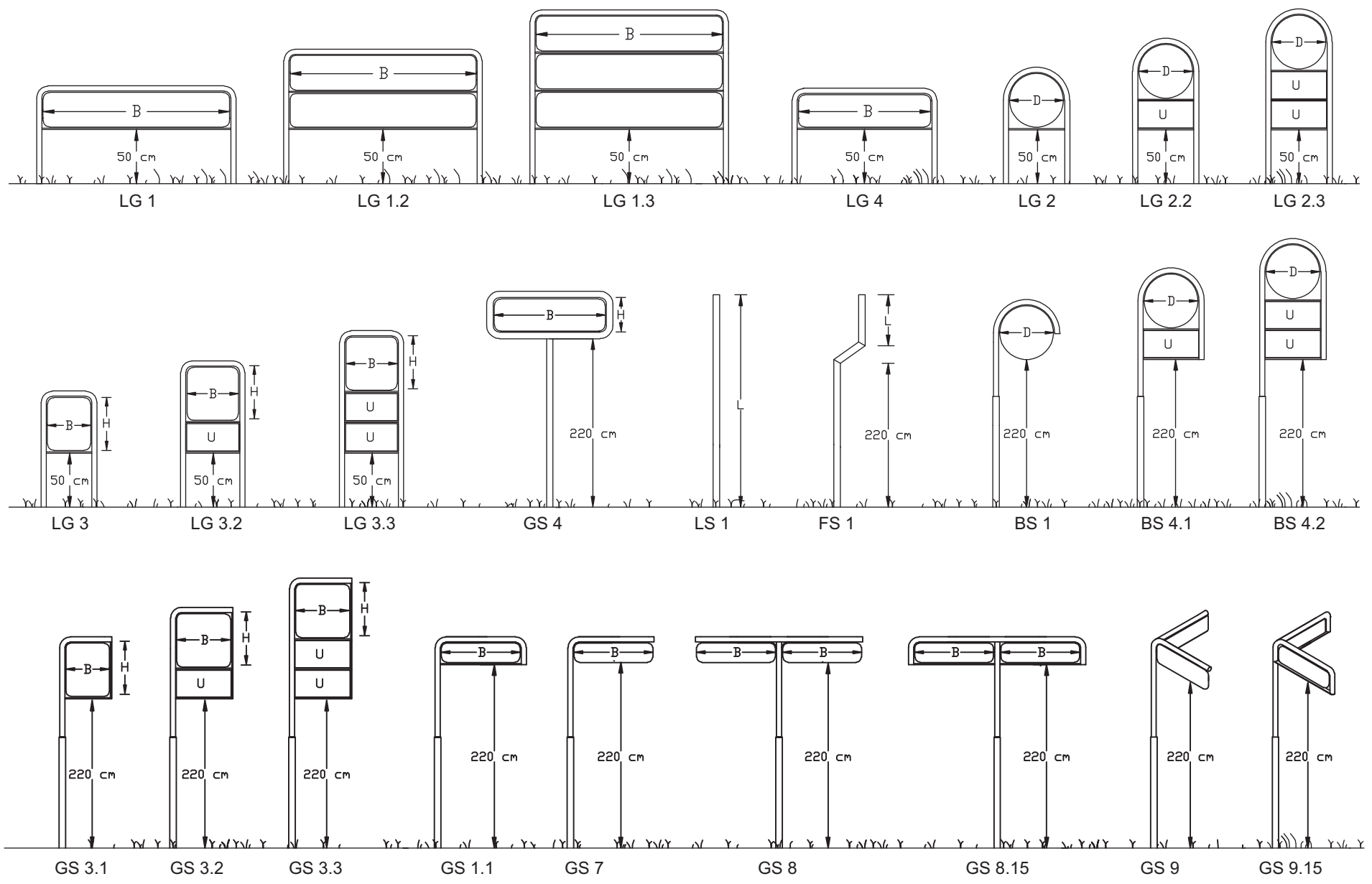

Montering med fladjernsbeslag

Montering på lapper

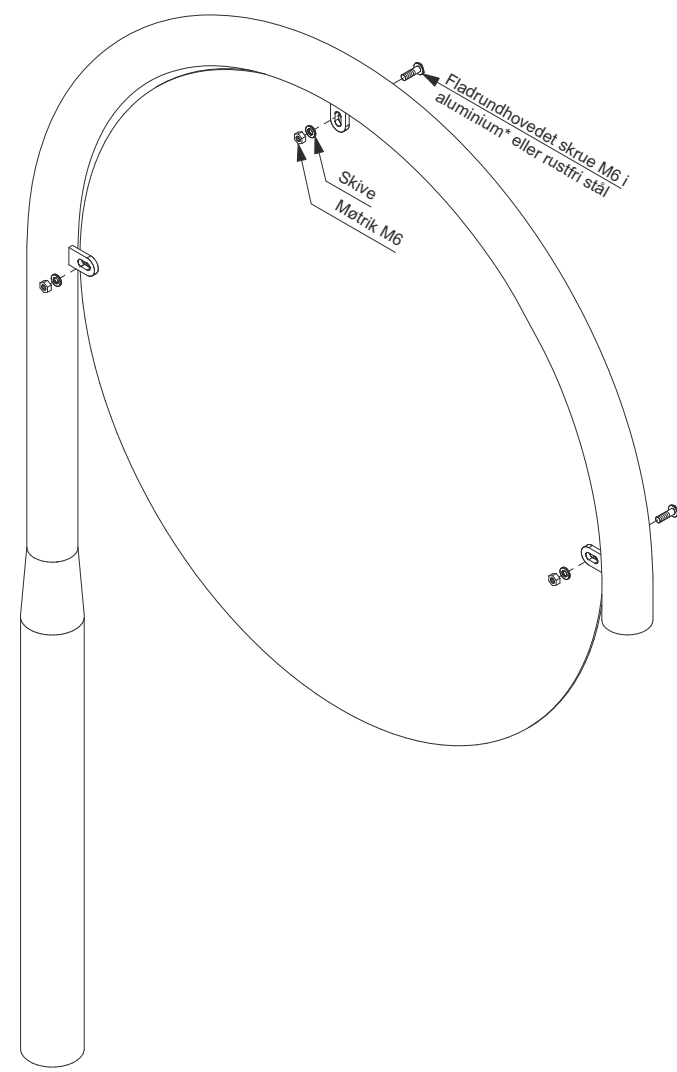
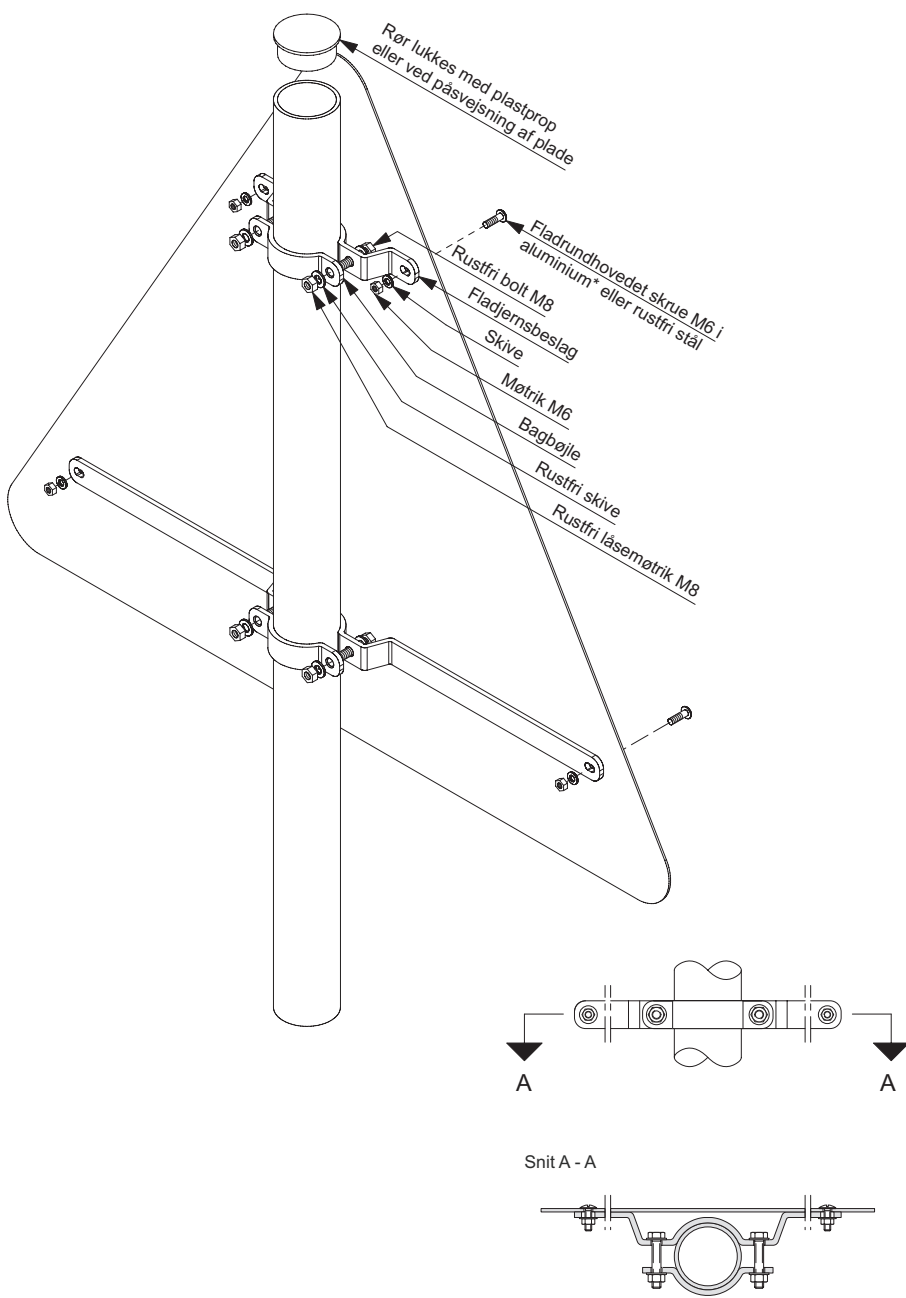

\* Brudstyrke Rm 270 N/mm<sup>2</sup> og R0,2 230 N/mm<sup>2</sup>

Montering med kæbebeslag (Kantform)

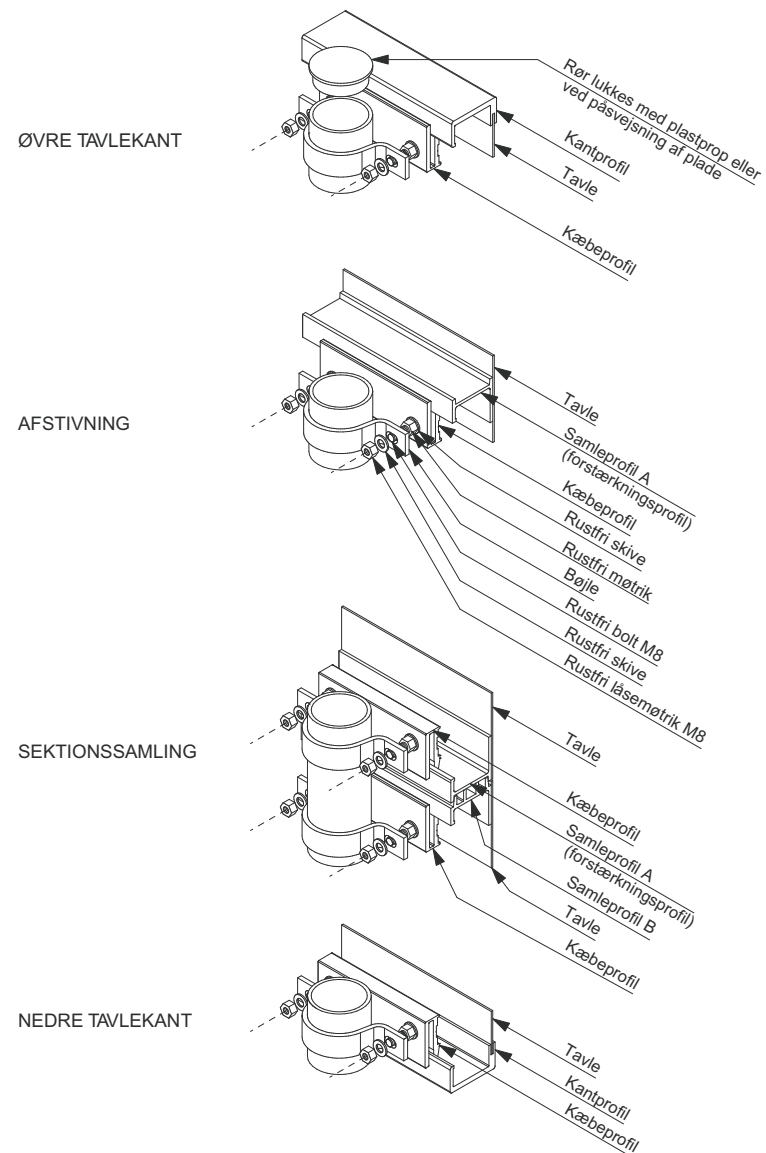
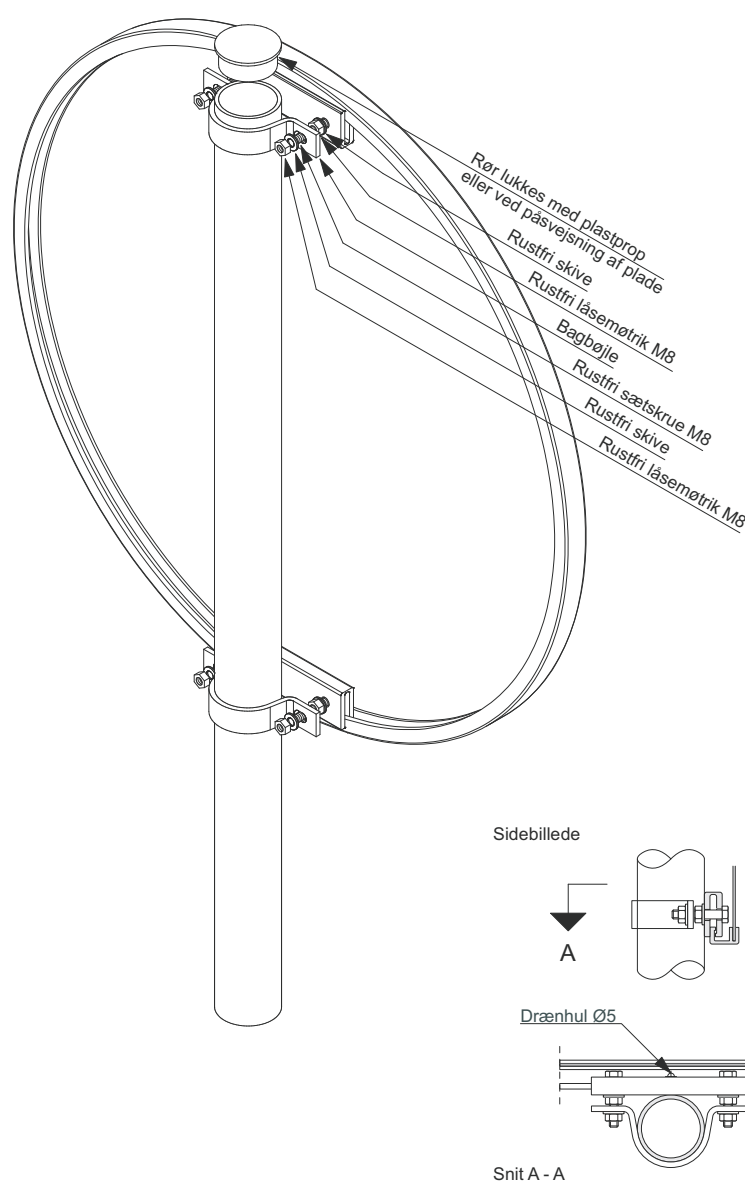

Seri Q Sign A/S